



# chainlink

Chain Link Industries of Qatar For Qatar



**PRODUCES THE BEST**  
**FOR ALL ABOUT FENCING**



**chainlink**

PROTECTIVE  
AND CREATIVE  
SOLUTIONS

# Content

**04** About  
Chainlink

---

**06** Products  
& Services

---

**08** Metal Fencing  
Coating

---

**09** Manufacturing  
Process

---

**10** Traffic Control  
Fencing

---

**12** Welded Mesh  
Fencing

---

**16** Chain Link  
Fencing

---

**20** High and Ultra High  
Security Fence

---

**22** Crash  
Barriers

---

**24** Palisade  
Fence

---

**26** Mobile / Temporary  
Fencing & Crowd  
Control Barriers

---

**28** Gates

---

**30** Steel Fabricated  
Fence

---

**31** Farm & Desert  
Fencing

---

**32** Concertina Razor  
Tape

---

**33** Barbed  
Wires

---

**34** Fixed & Surface  
Mounted Bollards

---

**35** Gabion  
Solutions

---

**36** Other  
Products

---

**38** Fence  
Erection

---

**39** Hoarding  
Fence

---

**40** Specialities  
Division

# ABOUT CHAINLINK COMPANY

CHAINLINK Industries of Qatar has been in the business as a dedicated fence manufacturer, supply and installation of a wide variety of fencing and related products, including residential, commercial and industrial fencing, guard rails, high security fence, animal and desert enclosures, portable toilets and much more for over 15 years with its manufacturing capacity situated at Bldg. 21 St. 3027 Zone 91 Birkat Al Awamer Al Wukair, Doha, State of Qatar.

CHAINLINK Industries of Qatar are equipped with professional, solid reputation of hard work and excellent engineering team to cater the unique needs of its clients through professional coordination. Our vigorous attention to detail at every stage is the principal reason that CHAINLINK Industries is the preferred partner for many residential and commercial engineering contractors.

We make every effort by continuous learning of innovations in order to keep track and adopt to the fast-paced technology. With our unique capabilities, we can custom build practically anything to fit your project requirement. Our large Inventory of readily available allows you to get what you need whenever you need it.



## MISSION STATEMENT OBJECTIVE

Our goal is to provide all of our customers with superior service, top quality materials and as much expert advice as needed to satisfy their requirements. We continually strive to improve our service and product mix to be the most responsive and efficient fencing contractor and fencing material supplier in State of Qatar to provide the best value, meaningful, fulfilling, and long-lasting job for our employees.

**Vision** To be the first to introduce innovative products and services in the market. We will be the most influential company of our kind in Qatar.

**Values** We must conduct ourselves with the highest moral and ethical values, deal fairly and honestly with our customers and employees. Our mindset must be to strive toward excellence in all aspect of our business. To give our customers a reason to tell their friends and associates about Chainlink Industries of Qatar for Trading.





SINCE  
**2007**

We focus  
on accelerating  
technical capability  
and innovation  
in fencing industry.

“

Chainlink is a very practical means of providing improved safety and security. Chain-link offers a balance between aesthetics and meeting the security and safety needs of residential and commercial property owners with an economical, long-lasting fence system.

”

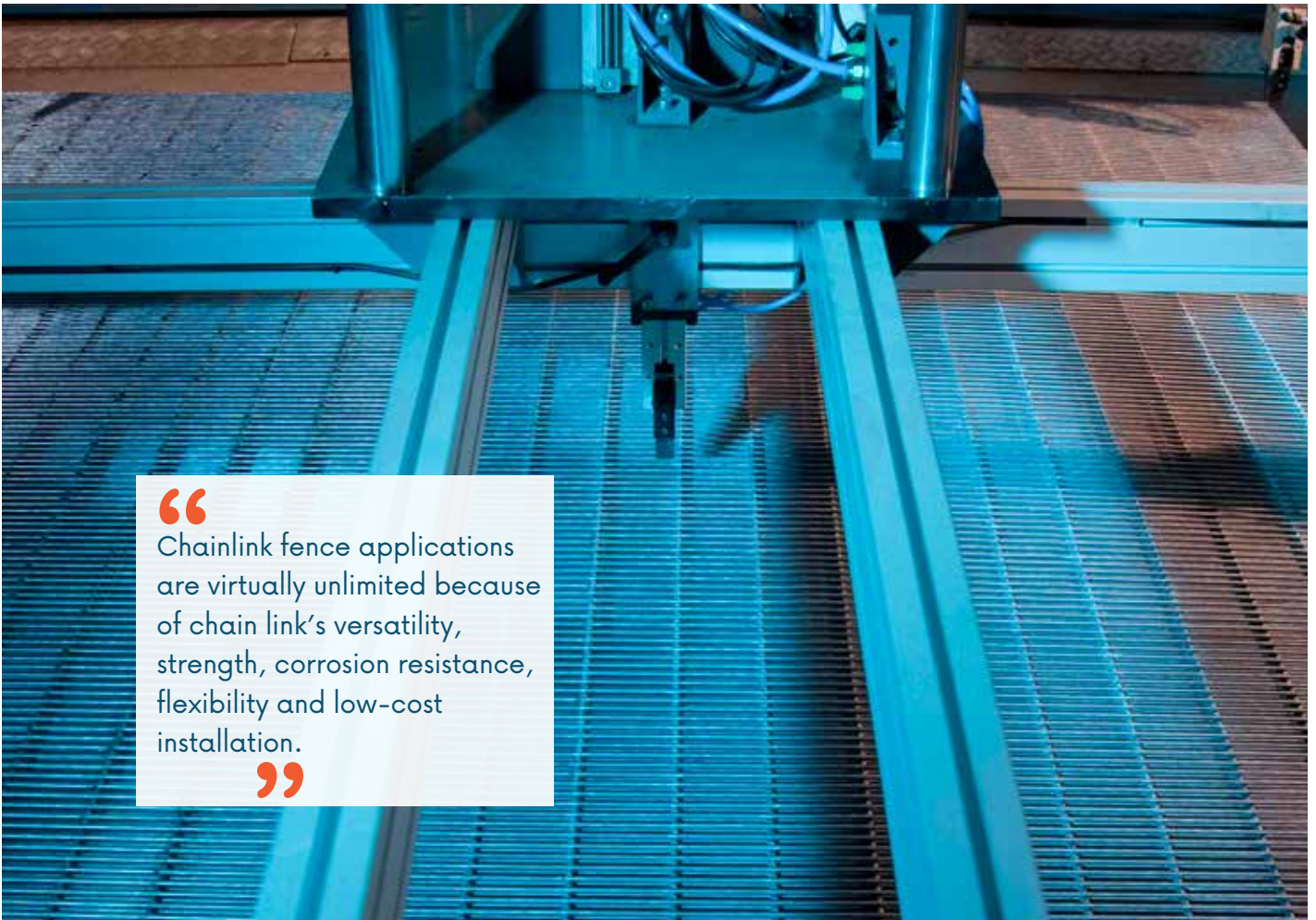

“

Chainlink fence applications are virtually unlimited because of chain link's versatility, strength, corrosion resistance, flexibility and low-cost installation.

”

# PRODUCTS & SERVICES

Chainlink Industries of Qatar is well recognized and has established itself as one of the leading manufacturers, suppliers and erectors of security fencing systems in state of Qatar.



- > TRAFFIC CONTROL FENCING
  - > WELDED MESH FENCING
  - > HIGH AND ULTRA HIGH SECURITY FENCE
  - > CHAIN LINK FENCE
  - > CRASH BARRIERS
  - > PALISADE FENCE
  - > MOBILE / TEMPORARY FENCING & CROWD CONTROL BARRIERS
  - > STEEL FABRICATED FENCE
  - > FARM & DESERT FENCING
  - > GATES
  - > CONCERTINA RAZOR TYPE
  - > BARBED WIRES
  - > PREFABRIC NEW SECTION
  - > FENCE ACCESSORIES
- 
- > METAL FENCING COATING
  - > FENCE ERECTION
  - > HOARDING FENCE
  - > SPECIALITIES DIVISION



# METAL FENCING COATING

Fences will be used to protect a parcel, delimitate a property or secure an area. Whatever it is, they need to withstand corrosion or any other exposure wherever they are placed. Therefore, long lasting protection become key.



Ornamental, welded mesh, chain link or any kind of fence type, each one brings its complexity for a coating process. We provide the adequate coating for all the different types of environment your fence could be subject to and the style of metal fence you use.

## Polyester Powder or Thermo Plastic Coating Colours





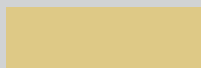

Our steel fencing and gate designs are supplied galvanized and powder coated to BS EN 13438 in one of our below listed standard colors.

The colors below are always available in our stock.

### THERMO PLASTIC COLORS

	RAL 1014
	RAL 6005

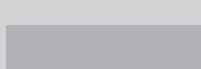
### POLYESTER POWDER COLORS

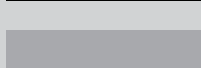
	RAL 1014
	RAL 1035
	RAL 5024
	RAL 6005
	RAL 7011
	RAL 7040
	RAL 9005
	RAL 9006





# MANUFACTURING PROCESS

We have a team of professional craftsmen in the workshop at our premises to ensure that every fence and gate we make is of the highest standard.

As a dedicated fencing contractor, we pride ourselves on providing our clients with a hands-on approach tailored specifically to their individual needs and requirements, offering this flexibility is what sets us apart. The quality of the fences we supply and install has enabled us to work on some large scale and exciting projects over the years.

Whether you are looking to increase your perimeter security, Pedestrian Safety or to keep wildlife out, we're here to provide you with the fencing solution you need.

Our experienced team is always available to discuss with you the best options for your perimeter fencing to ensure maximum security and safety at all times.



# TRAFFIC CONTROL FENCING

An ideal material for industrial metal wire fencing our welded wire mesh is designed and manufactured to be strong, durable and able to withstand harsh environments.

Offers reliable and aesthetic medium-security welded wire mesh with larger apertures.

Pedestrian Guard Rail system guard railing has been purposely designed for use around roads, to keep pedestrians safe or to create a barrier keeping traffic contained to the road. This metal railing is exceptionally strong with solid pales welded to tubular rails but at the same time allows good visibility to road users.

## USING AREAS

Roads

Hotels & Resorts

Gas stations and other service stations

Shopping malls and department stores

School parking lots

Parking garage and other allied commercial locations.

Construction and roadwork zones

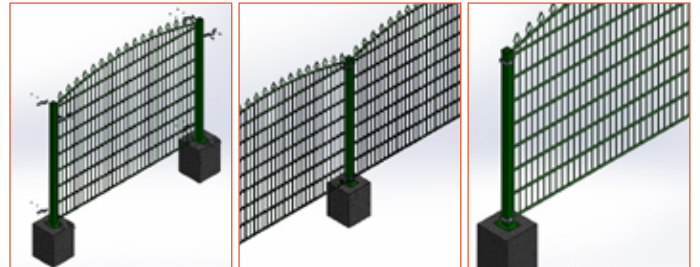



### PEDESTRIAN FENCE WELDED MESH

CANFOR DOUBLE PANEL FENCE					PROFILE POSTS					
HEIGHT	COATING	LENGHT	MESH SIZE	VERTICAL WIRE DIAMETER	HORIZONTAL WIRE DIAMETER	SIZE	CLIPS	CAP	HEIGHT	
									BASE PLATE	EMBEDDED
910mm	Thermoplastic and/or Polyester Powder coating over galvanized surface	1980mm	60x200mm	Ø6mm	Ø6-8mm	60x60 1.50mm -2.00mm	2	1	880mm	1200mm
1100mm							3		1000mm	1500mm
1310mm							3		1250mm	1700mm
1510mm							3		1450mm	1850mm
1710mm							4		1650mm	2000mm
2110mm							4		2000mm	2500mm

# WELDED WIRE MESH FENCE

Welded wire mesh fence is extensively used for different heights and sometimes in conjunction with Chain Link fence for dual security. These are also used as decorative fences with polyester powder coating or PVC Coating in green color RAL 6005. Welded fences come in many designs, wire sizes and profiles, used for parking lots, children play grounds, schools, city roadway pedestrian barriers and public parks to prevent intrusion simultaneously providing good aesthetic looks.

Wire diameters have choice of 2.50/3.0/3.76/4.0/5.0/6.0/ 8.0 mm GI Wires, fabrication is done using specialized spot welding machines at every intersection. Welded wire mesh fences can be supplied in any height upto 8.0 meters.

Posts are specially designed steel sections usually in GI or GI & Powder coating or alternatively with PVC coating with plastic caps these can be fixed with base plate on continuous cast concrete beam or grouted to concrete foundation. Fasteners – Panels and posts are assembled together with bolts using flat steel bar, with special steel clamps or clips and self-locking bolts and nuts.

## USING AREAS

Industrial Zones

Roads

Commercial Areas

Residential Areas

Park & Gardens

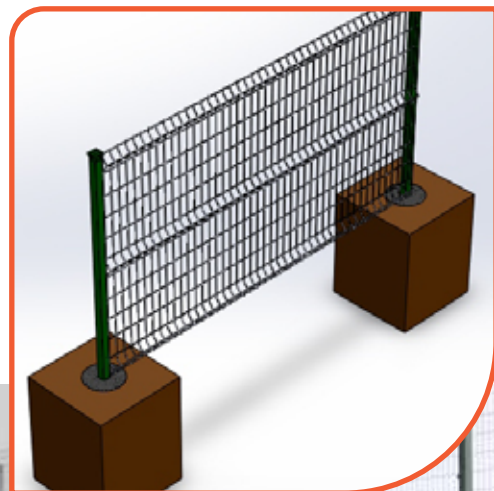



Double Welded Mesh

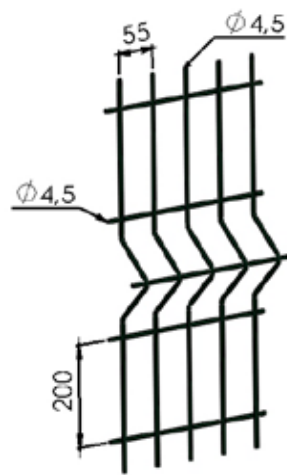

3d Welded Mesh

### COLOR OPTIONS

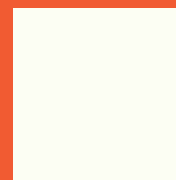

RAL 9010  
SNOW WHITE

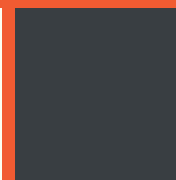

RAL 7016  
ANTHRACITE



RAL 7030  
STONE GREY



RAL 6005  
FENCE GREEN



RAL 6073  
GRASS GREEN





## FITTINGS

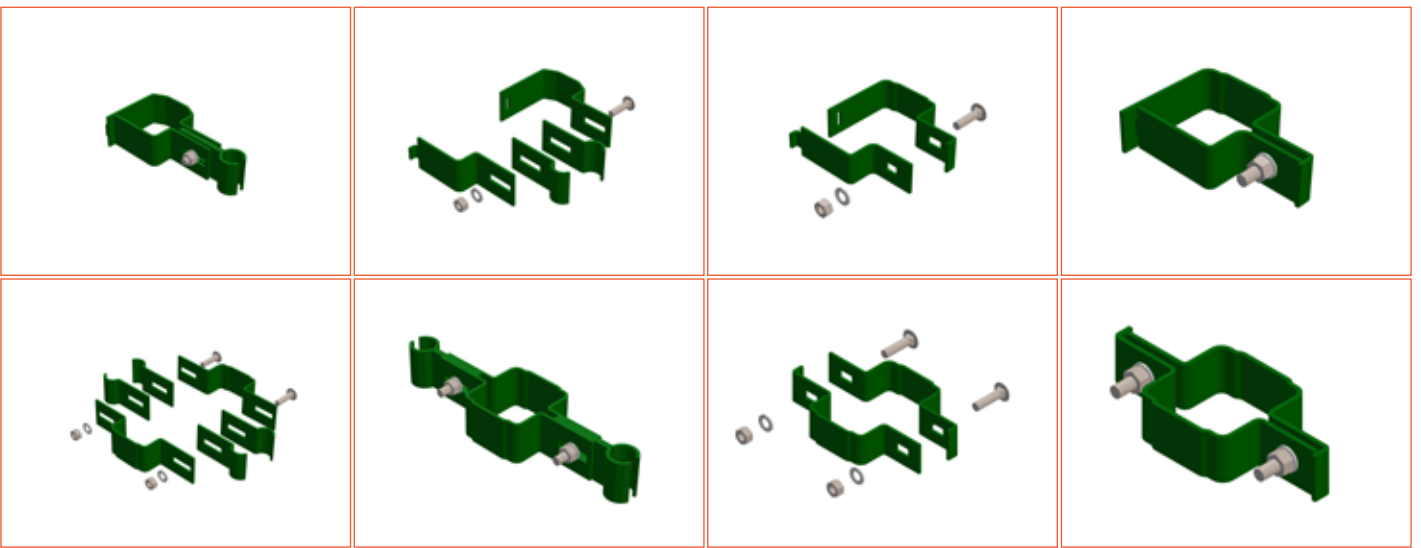

## DOUBLE PANEL WELDED MESH

DOUBLE PANEL FENCE					FENCE POSTS					
HEIGHT	COATING	LENGHT	MESH SIZE	VERTICAL WIRE DIAMETER	HORIZONTAL WIRE DIAMETER	SIZE	BRACE CLAMP	POST CAP	HEIGHT	
									BASE PLATE	EMBEDDED
830mm	Thermoplastic and/or Polyester Powder coating over galvanized surface	2500mm	50x200mm	Ø5-6mm	Ø6-8mm	60x60 1.50mm -2.00mm	2	1	800mm	1200mm
1030mm							3		1000mm	1500mm
1230mm							3		1200mm	1700mm
1430mm							3		1430mm	1900mm
1630mm							4		1630mm	2000mm
2030mm							4		2000mm	2500mm
2430mm							5		2430mm	3000mm

## 3D WELDED MESH PANELS

3D WELDED MESH FENCE					FENCE POSTS					
HEIGHT	COATING	LENGHT	MESH SIZE	WIRE DIAMETER	UNITS OF BENDINGS	SIZE	CLIPS	POST CAP	HEIGHT	
									BASE PLATE	EMBEDDED
500mm	Thermoplastic and/or Polyester Powder coating over galvanized surface	2500mm	50x150mm	Ø4,5mm	Ø6-8mm	60x60 1.50mm -2.00mm	2	1	500mm	1000mm
800mm							2		800mm	1200mm
1000mm							3		1000mm	1500mm
1250mm							3		1250mm	1750mm
1500mm							4		1500mm	2000mm
2000mm							4		2000mm	2500mm
2400mm							5		2400mm	3000mm

# CHAIN LINK FENCE

Chainlink Industries manufactures chain link fence galvanized and PVC finishes using high speed double spiral weaving machines with latest touch-screen setting and diagnostic technology, assuring consistent quality, adherence to specifications and repeatability which assures smooth fence line and a meticulous control over height of the fence, over thousands of linear meters. Color of fabric can be galvanized, green and beige which are available ex-stock, while grey and black can be manufactured against specific orders and will have delivery period depending on quantity.

Fence posts can be supplied in a wide range of choice in styles and dimensions as below:

- "L" Angle Posts
- CHS - Circular Posts
- SHS / RHS - Square / Rectangular Posts
- "I" Section Posts
- "H" Section Posts

## USING AREAS

- Industrial Zones
- Road Edges
- Railways
- Airport Fencing
- Sports Areas
- Zoos & Gardens & Parks

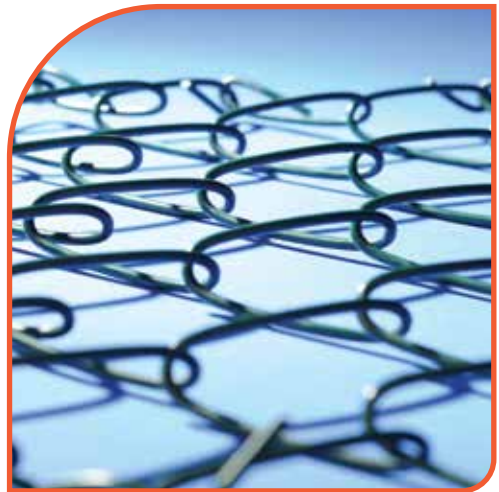

## COLOR OPTIONS

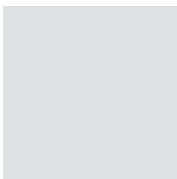

GREY RAL 7047  
GI FINISH



RAL 6005  
GREEN



RAL 1014  
BEIGE

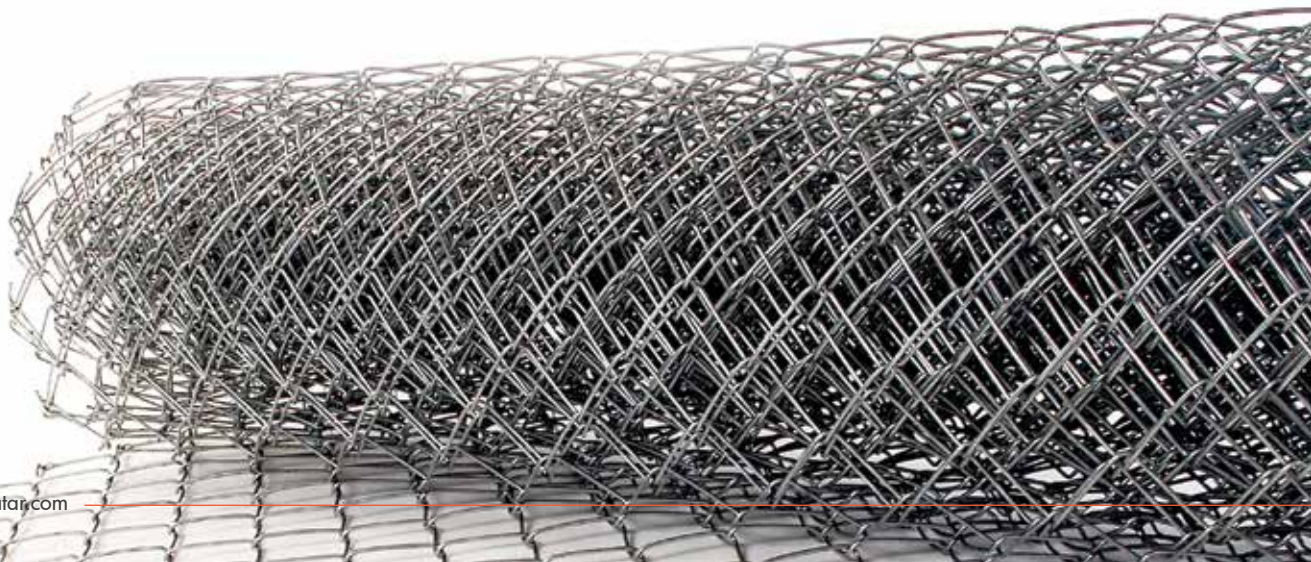





Finish of posts is to match with the fabric in hot dip galvanized GI, GI+Powder coated and GI+PVC plastic coated, GI + Epoxy coated in wide range of color choice.

GI sections are procured directly from steel mills in GCC, Turkey and India, as per ASTM or BS specifications. Generally, specifications of fence posts conform to ASTM grade A53, schedule 40.

Fence fittings are heavy duty GI fittings to securely hold fabric to line, straining and gate posts. Fence fittings are epoxy coated, powder coated or PVC coated GO to match the posts in identical color.

Chain link fences have a wide range of applications and specifications depend on usage and durability required i.e. temporary or permanent:



- > BOUNDARY DEMARCATION FENCE
- > SPORTS PLAYGROUND FENCE
- > CONSTRUCTION SITE FENCE
- > SECURITY FENCE
- > HIGH SECURITY FENCE
- > HIGHWAY SAFETY FENCE
- > DOG KENNEL FENCE
- > ZOOLOGICAL PARK FENCE
- > BIRD CAGE FENCE



#### WIRE SIZES

						
GI	4,85mm	4mm	3,76mm	3mm	2,5mm	2mm
PVC	4,88mm	4mm	3,76mm	3mm		

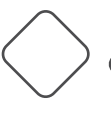
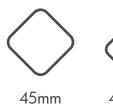
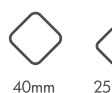
#### MESH SIZES

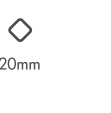
					
60mm	50mm	45mm	40mm	25mm	20mm





# HIGH & ULTRA HIGH SECURITY FENCE

ULTRA Fence is a high security fence providing long term high security fence for application in Prisons, Army and Air force camps or installations at high sensitivity, Airports, Oil and Gas field installations, Boundary fence at borders with neighboring countries, water desalination plants, Power plants, Ports, Palaces and diplomatic offices, compounds and residences. Heavy zinc coating on the fabric mesh wire to the tune of 610 gms/m<sup>2</sup> as per ASTM A- 392, CLASS 11(2) , ends are barbed selvage to provide deterrent sharp edges. While minimum recommended height of fence is 2.40 Meters, heights upto 4.0/6.0 meters can be used depending upon sensitivity of the location and threats anticipated, while 300 mm might be provided to bury the fence fabric below ground level, preferably in a continuous concrete beam, to make it scaling proof. Additionally, over the fence posts 'V' crank is required, 600 mm each side to place 6 rows of barbed wires and support and fix one continuous concertina Razor tape of diameter 900mm or 1,000mm, which are optional, but makes Ultra Anti Intruder fence. (Specifications of concertina Razor tapes is given in the following pages)

This fence is strongly recommended for coastal and corrosive areas as heavy Galvanizing on the wire to the tune of 610 gms/m<sup>2</sup> acts virtually as cathodic protection against corrosion over years of usage.

Line Posts should be Minimum 60 mm OD with straining and corner posts 73 or 89 mm OD, to match the fabric color it is recommended to apply Epoxy paint or Powder coat to posts over GI coating as per ASTM Sch 40 Grade A53, in matching grey or silver color.

## USING AREAS

- Industrial Zones
- Sensitive areas
- Mining and oil zones
- Penitentiary areas
- Houses and places of residence located in sensitive areas
- Consulates, embassies and administrative buildings



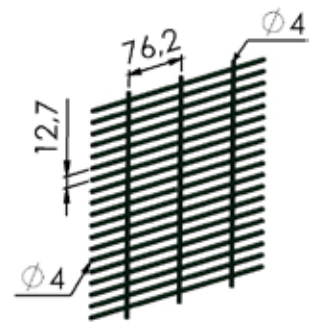

High Security Fence

### HIGH SECURITY WELDED MESH FENCE

HIGH SECURITY FENCE				PROFILE POSTS			
HEIGHT	LENGHT	MESH SIZE	WIRE DIAMETER	SIZE	CLIPS	HEIGHT	COATING
1500mm	2518mm	12,7mm x 76,2mm	4mm	60x80x3mm	5	2000mm	Thermoplastic and/or Polyester Powder coating over galvanized surface
2000mm					6	2500mm	
2400mm	2210mm				7	3000mm	
3000mm					8	3600mm	

# CRASH BARRIERS

Seyaj, provider of Alka Barrier products and barrier posts with our partnership provide high quality crash barrier solutions for roads, highways and much more.

The experienced team at Seyaj can help you with all aspects regarding crash barrier solutions.

We stock a wide range of barrier products including crash barrier beams, crash barrier posts, open box beam barriers and more. Operating our own stock management system allows us to offer extremely fast turnaround times, ensuring that the quality of the products that we supply is to the highest standard.

## USING AREAS

Roads

Highways

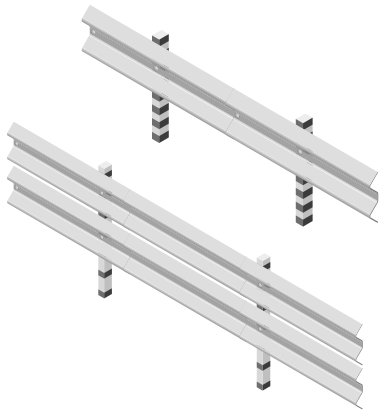



# PALISADE FENCE

The security of your property is no doubt a excessive concern to your business. Palisade fencing is designed to provide a formidable long-lasting barrier against would be intruders. This makes it one of our highly durable fencing options. Made from high quality steel, our palisade fencing is made in a wide range of specifications for differing levels of security needs.

In today world "security" is of paramount importance and in crime and vandalism world over has dictated a need for a security perimeter fence which offers" protection" in terms compared to conventional fences available in market which are not full proof and can easily be tempered with.

Palisade fencing system provides a formidable barrier and is manufactured from cold roll formed steel sections designed to provide strength and rigidity, which offers excellent performance in standard height from 1.2m to 3.60m.

A wide range of specification are available offering a choice of "D" type or "W" type pale section which are offered with a vany of heads chosen by the risk assessment for a particular site.

Palisade fencing is supplied in 2.75m wide panels complete with security fastenings all steel components are pre-fabricated and pre-punched-drilled for speedy on site assembly and erection.

Palisade fence has been widely successfully used the following application as a cost effective means of security fencing. Industrial, power generation stations, electricity substation, gas installations, oil terminals, fuel terminals, military installation, magistrates courts & airport perimeters.

## USING AREAS

- Industrial Units
- Utilities Companies
- Airports
- Highways & Railways
- High Security
- Powerstations
- Dams and Reservoirs

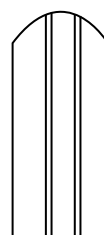

Rounded

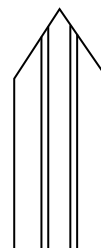

Pointed

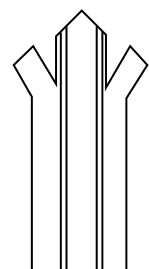

Triple Pointed





# MOBILE / TEMPORARY FENCING

Frame panel system with PVC base for temporary protection and control of crowd and vehicles.

## USING AREAS

- Construction Sites
- Factory Inner sides
- Crowded Areas
- Events & Festivals
- Airports
- Sport Organizations



# CROWD CONTROL BARRIERS

Pedestrian safety should be first and foremost on and around civil projects, work sites, events and festivals. Chainlink's crowd control barriers are quickly and easily erected to form a continuous barrier between pedestrian traffic and possible danger, to provide safety and organization at public events. The crowd control barricades are perfect for helping to guide civilian traffic, ensuring that you keep them safe and restrict people from venturing into restricted areas.

Standard Barriers measure 2000mm x 1000mm and are constructed from galvanized steel. Featuring double interlocking hinge points, this crowd control barrier provides excellent stability. The interlocking hinge system makes installation quick and easy, and panels are designed with or without removable feet that can be taken off during stacking and storing.

## Advantages;

- Light but sturdy design
- Anti-Trip Feet Available
- Rotatable Feet for portability
- Long Lasting - Hot dipped galvanization for durability and all weather use
- Easy to handle - Carry 2 at a time
- Barricades stack within each other for better storage
- 100% recyclable

## USING AREAS

- Temporary Walkways
- Public Events
- Landscaping
- Road Work construction
- Utility Works
- Events



# GATES

As well as wide range of fencing solutions, Seyaj offers hinged, welded mesh and chain link security gates.

These can be standard swing gates (single or double leaf) and (sliding or cantilever) gates. Gates can be supplied galvanized, PPC (Polyester Powder Coated), TPC (Thermo Plastic Coated) or Epoxy painted only.

## SWING

We manufacture sturdy heavy duty gates to match the ChainLink fence aesthetically, both single leaf man gates and double leaf vehicle entry gates. Gates are designed of sturdy construction as gates undergo maximum use, wear and tear, being extensively used and handled.

Gate frame is made of heavy duty construction, using ASTM Sch. 40 GI pipe frame from 48.3/60.3 mm OD Pipes, with 42.3 mm bracing.

## SLIDING / CANTILEVER

We offer Sliding gates with Tubular CHS, SHS or RHS sections, infill can be ChainLink fabric, RHS infill or ornamental with sturdy and rugged construction.

ChainLink infill sliding gates are equipped with Teflon wheels and easy to operate manually on concrete surface. While GI steel fabricated gates slide on inverted GI 'L' angles embedded in RCC. Gates are lockable to the end posts using a padlock or electrically operated solenoid lock.

### USING AREAS

Industrial Buildings

Schools

City Councils

High Security





## GATE & DOORS

TYPE OF MODEL	HEIGHT	LENGHT	FRAME	IN FRAME	COATING
SERVICE DOORS (PEDESTRIAN GATES)	800-2500mm	According to customer request	Profile and/or Pipes	Single Panel Fence, High Security Fence, Double Panel and Chainlink	Powder Coating Over Galvanized, Hot Dip Galvanized Or Oil (Epoxy) Painting
SLIDING GATES	800-2500mm	Between 3m & 16 m	Profile and/or Pipes	Single Panel Fence, High Security Fence, Double Panel and Chainlink	Powder Coating Over Galvanized, Hot Dip Galvanized Or Oil (Epoxy) Painting
CANTILEVER GATES (WINGS)	800-2500mm	Between 3m & 13 m	80X100*3mm Profiles	Single Panel Fence, High Security Fence, Double Panel and Chainlink	Powder Coating Over Galvanized, Hot Dip Galvanized Or Oil (Epoxy) Painting

# STEEL FABRICATED FENCE

Ornamental and Grill metal railings can provide good levels of security without losing the decorative and traditional edge to enhance the exquisiteness of the property and application. The railings can be used for roadside fencing, city councils, schools, sporting facilities boundary fencing and security fencing, all available in any powder coated colour of your choice.

## USING AREAS

- Schools
- Roadside Fencing
- City Councils
- Sporting Facilities
- Villas



# FARM & DESERT FENCE

Desert fencing system is mainly used as an anti-intrusion barrier against farm and other animals. The most common use is on highways, where vast distances are covered at a very economical cost. Animal fencing can also be used to enclose areas such as farms, desert areas and national parks, where security is not critical. This system is easy to install and can be erected in a comparatively short-time.

We supply fixed knot Camel fence for highway security, also called Right of Way (ROW) fence to ensure that cattle and stray camels do not cross at undesignated places, causing serious & fatal road accidents.

Seyaj Trading Camel fence is temper proof, as knots cannot be opened with ordinary tools, posts IP120 & IP 80 are placed 10 meters apart grouted in concrete mix Fence fabric supplied in rolls of 70 or 100 linear Meter lengths, while 200 meter rolls are optional, since bulky to handle. Fence fabric is supplied with pre-stripped roll ends for very easy and fast to erect with less reliance on labor.

Camel fence can be supplied with a choice of 3 optional knots as below; these are manufactured using exclusive & revolutionary machine knot making technology. Each knot design while providing desired security ensures that Camels/ cattle is not bruised, while dashing, leaning or scratching against the fence.

Fence design comprises of 11 rows of horizontal line wires and vertical staywires 50 or 100 mm apart. High tensile top and bottom 3.50 mm line wires together with 9 nos 3mm line wires and 3mm medium tensile stay wires.

## USING AREAS

- Farms
- Desert Areas
- National Parks



DOUBLE LOCK KNOT



SPIRAL KNOT



X- KNOT



# CONCERTINA RAZOR TYPE

CHAINLINK Industries product range offers Concertina Razor tapes and ribbons in GI finish or Stainless Steel finish in four different blade forms small, medium, long and fishhook, while medium blade (BTO-22) is a stand-ard off the shelve product, other 3 types can be supplied against specific orders.

Specifications of Concertina razor tapes as summarized below, blade thickness is 0.5 mm and core wire 2.50 mm high tensile GI wire ( for concertina coils only )

## USING AREAS

Industrial

Military

Governmental

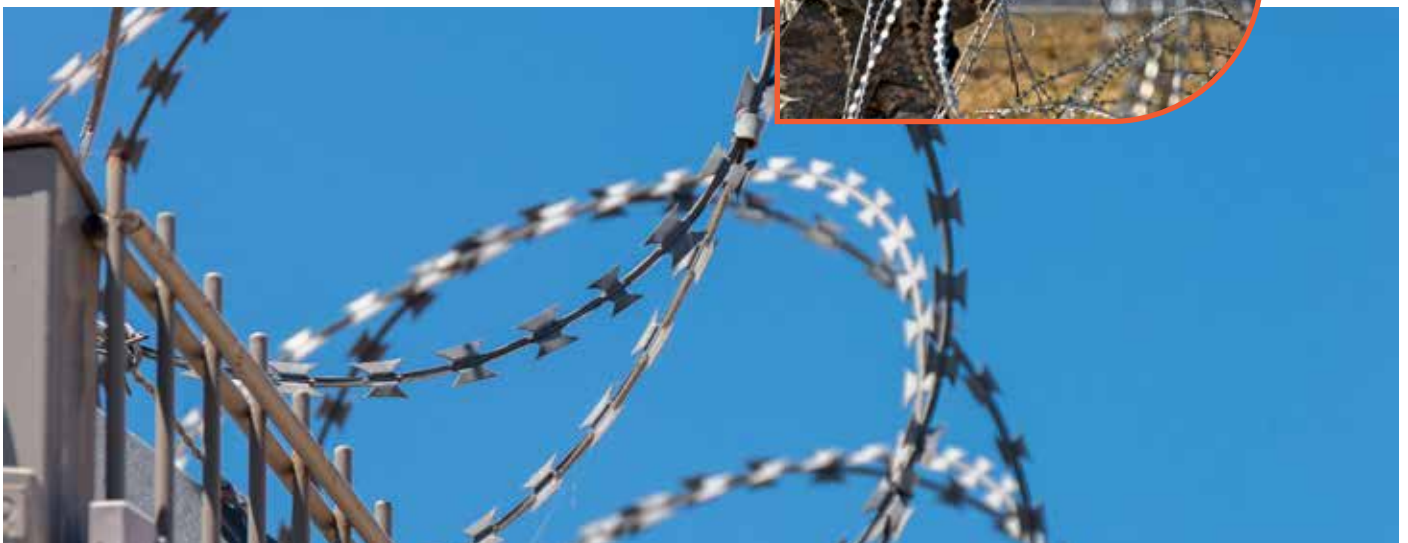
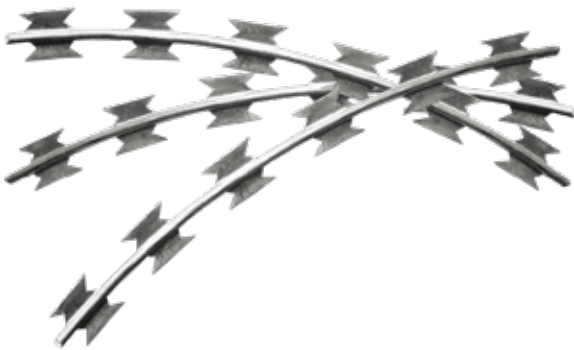



# BARBED WIRES

Barbed wires possibly are the first form of a formal steel fence developed by humankind and date back thousands of years old invention, first hand made and later machines were developed to manufacture the same to meet the growing demand. Still used as intruder prevention with ChainLink fence and Palisade fence, in formation of 3 rows/6 rows or 7 rows on the top with a suitably designed barb arm, gap between the barb wires is kept at 150/200 mm uniformly.

CHAINLINK industries offers IOWA pattern barbed wires in GI and PVC coated finishes matching the fence fabric.

Construction comprises of 2 rows of twisted GI wires of 2.50 mm OD and 4 Barbs of 2.0 mm wire generally placed 100 mm apart, with spiked edges, to hurt the intruder resulting as effective low cost deterrent. Security experts recommend the spikes should be allowed to get rusted as they cause septic to the intruder.

## USING AREAS

- Railways and highways
- Industrial Areas
- Residential Areas
- Construction sites
- Prisons, military and governmental zones



# FIXED & SURFACE MOUNTED BOLLARDS

Our range of surface Mounted Bollards and fixed Bollards are available in a wide range sizes and custom colors. The Bollards are also available with chain rings with a reflective strip. We can also supply steel & Stainless steel bollards surface mounted or embedded in concrete Bollards are available different finishes.

## USING AREAS

- Airports
- Militaries
- Public Areas
- Governments
- Schools



# GABION BOXES SYSTEM

There are numerous uses for these Gabion modular units and are typically used to form flexible, permeable and monolithic structures such as retaining walls, channel linings, hydraulic control structures and erosion protection. They are increasingly being used in architectural applications as well.

## USING AREAS

Architectural Cladding

Garden Walls

Retaining Wall

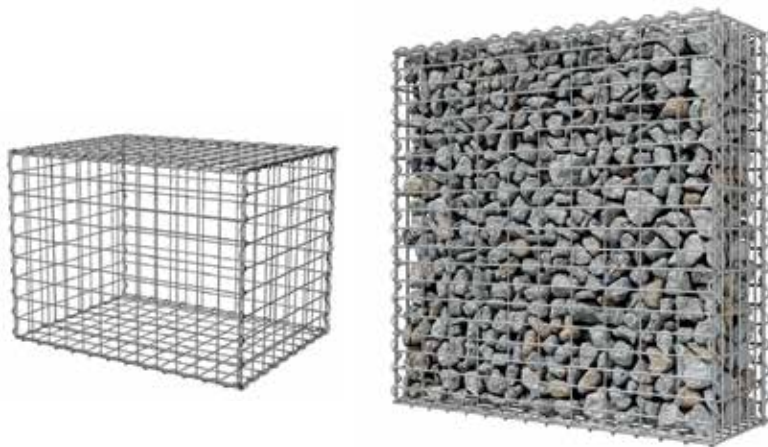

# OTHER PRODUCTS

HOARDING FENCE



MOBILE FENCE



CROWD BARRIER



PEDESTRIAN FENCE



PIPE RAILING SYSTEM



ORNAMENTAL FENCE



**QP CULVERT**



**WATCH TOWER**



**CHILDREN PLAY AREA FENCE**



**STAINLESS STEEL HANDRAIL**



**GLASS BALUSTRADE**



**STAINLESS STEEL BOLLARDS**



# FENCE ERECTION

We provide turnkey fencing solutions from CAD designing to manufacturing, supply and erection. We have several highly skilled teams of fence erectors, for speedy and quality erection of security fence any time in the state of Qatar.

We can also carry out fence erection anywhere at your site globally. Supervised by site engineer, our team can work in all weather conditions and site locations as project may demand, completely adhering to specifications and Drawings. While gate passes and first aid at site remains contractor's responsibility, our erectors always apply required P.P.E as per site H.S.E requirements.

Our staff undergo in-house safety training courses and refresher programs and follow CHAINLINK Industries standard fence erection manual duly approved by many consultants. Our team uses special tools as required for fence erection. Accordingly, we can offer turnkey safety fence services as may be required to meet your requirements.



# HOARDING FENCE

Hoarding is a temporary structure of solid construction, erected around the perimeter of construction sites to shield them from view and prevent unauthorized access. It is an important component in ensuring health and safety, for site workers, visitors and the general public and can also be part of a site security system to prevent theft or vandalism. Hoarding can also help to make sites less intrusive and more aesthetically pleasing to people living and working in close proximity, and can minimize disturbances and improve privacy, both for the general public and for workers on site.

Hoarding can be a temporary or long-term installation and may be free-standing, or built into the site.

It is important that it is structurally stable, as it can be exposed to strong wind loads, or impact. It can be a modular system or a bespoke installation and can be made using a wide range of materials such as steel, timber or plywood which may be re-useable or disposable.

Hoarding can include barriers, gates, viewing windows, areas of fencing and so on and may be used to display warning and information signs. It can be branded, used for marketing and promotion to advertise the contractor or developer, or can be used to show people what the completed project will look like and how it will impact the local area.



# SPECIALITIES DIVISION

## MODULAR CONTAINERS

2 assembled units or 10 Flatpacks can be transported on a flatbed trailer.

Single modules can easily be joined across both a longitudinal and transverse plan, allowing for open plan halls and larger structures to be designed and assembled as required.





# PREFABRICATED BUILDINGS

- Workers Dormitories / Camps
- Site offices
- Engineers Accommodations
- Military Camps
- Kitchen facilities
- Laundry units



## CABIN CONTAINERS

Chainlnk Cabins can be utilised for a wide range of service areas including;

- Security Cabin / Guard Room
- Kiosk / Shop
- Information Centre
- Taxi / Valet Station
- Ticket Office
- Toilet / Shower units

Our cabins are manufactured with a galvanized light steel structure, all connections are by screws and bolts, elimination any welding process.



# MODIFIED SHIPPING CONTAINER

Dry Storage Containers  
Chemical Storage Containers  
Insulated Storage Containers,  
Custom Modification



## OPEN TOP



STANDART 10' / 20' / 40' / HIGH CUBE 40'



## FLAT RACK CONTAINER



# RACK & STORAGE SYSTEM

Chainlink Industries of Qatar have partnered with Temesist® in 2017 to cater for Qatar's market needs of high quality and cost efficient storage and warehouse racking solutions.

For over twenty years Temesist® has remained as one of the largest and most reputable manufacturers of storage and semi-automatic rack systems in Turkey specializing in designing, manufacturing and marketing industrial racking products.

From its foundation up to the present Temesist® produces various kinds of high quality and economic rack systems using high quality and economic rack systems using high level technologies, which let to be in line with the latest international standards in this sector.

Head office is located in Istanbul and branches are in Adana and Belicik. There are representation offices in Algeria, Iraq, Georgia, Kazakhstan, Jordan, Uzbekistan, Brazil, UAE, Qatar, Saudi Arabia, and Greece.

Temesist® has an international quality certificate ISO and produces products according to EN15512 and RMI standards, Temesist® exports its high quality products to over 30 countries including Germany, Croatia, Bulgaria, Azerbaijan, Kazakhstan, UAE, Senegal, Sudan, Ukraine, Iraq, Algeria, Georgia, Uzbekistan, Also has been attending the worldwide known exhibitions for years and has become an international representative of Turkey.

Temesist's working principle is based on the customer satisfaction and reliance, Temesist(R) is continuously involved in research and development projects.

R&D team works closely with product managers and engineers at our manufacturing plant in Turkey carrying our detailed studies on ways to improve our current systems to benefit our end customers.

SELECTIVE PALLET RACKING



VNA RACKING SYSTEM



DRIVE IN RACKING SYSTEM



FLOW RACK SYSTEM



PALLETTE SHUTTLE



CANTILEVER RACKING



AS / RS SYSTEM



MEZZANINE RACKING SYSTEM



RACK CLAD BUILDING





**NOTE:**

Please specify following while ordering / sending enquiry:

Quantity required and height of fence.

Size OD of pipe for which brace bands / tension bands / post caps & barb arms are needed.

Finish - Galvanized, Galvanized + Powder Coated or Galvanized + PVC coated. Standart color is RAL 6005 Fence Green, please specify color if required color is different.

Availability is subject to store stocks.



# chainlink



[www.chainlinkqatar.com](http://www.chainlinkqatar.com)  
[info@chainlinkqatar.com](mailto:info@chainlinkqatar.com)



+974 4451 0413 / +974 3125 2555



Economic Zone, BirkatAl Awamer,  
Zone 91 Street: 3027 Building: 71  
PO BOX: 40125 QATAR